

Installation Guide / 安裝說明書 / Guide d'installation / Montageanleitung / Guía de instalación

インストレーションガイド

- * Case components * Composants du boîtier * Guía de instalación
- * 機殻部品紹介 * Gehäusekomponenten * ケース各部紹介

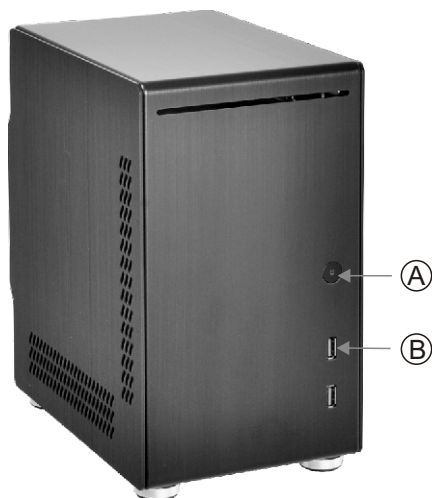

- (A) Power switch
電源開關按鍵
電源スイッチ
- (B) Multi-media ports (USB 3.0 x 2)
多媒體連接埠 (USB 3.0 x 2)
マルチメディアI/Oポート (USB 3.0 x 2)
- (C) PCI slots with ventilation
PCI 通風擋片
通気構造のPCIスロット
- (D) Removable ODD tray (Slot-in Slim ODD x1 or 2.5" HDD x 1)
薄型光碟機托盤 (可安裝薄型光碟機 x1 或 2.5" 硬碟 x 1)
リムーバブルODDトレイ (Slot-in Slim ODD x1 or 2.5" HDD x 1)

- (E) Female clip for side panel
母卡筍
サイドパネル用メス型クリップ
- (F) HDD install location (3.5" HDD x 1 or 2.5" HDD x 1)
硬碟安裝孔位 (3.5" 硬碟 x 1 或 2.5" 硬碟 x 1)
HDD取付スペース (3.5" HDD x 1 or 2.5" HDD x 1)
- (G) Removable HDD tray (2.5" HDD x 2)
可拆硬碟托盤 (可安裝 2.5" 硬碟 x 2)
リムーバブルHDDトレイ (2.5" HDD x 2)
- (H) Removable air filters
可拆濾網
脱着式エアフィルター

- * Hardware list * Liste des pièces * Lista de materiales
- * 零件盒部品一覽表 * Hardwareliste * 付属品一覽

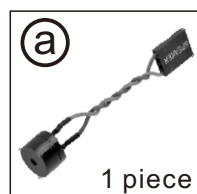

1 piece
Buzzer for M/B alarm
マザーボード用
ブザーユニット

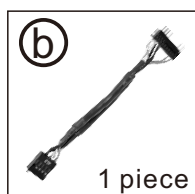

1 piece
USB 3.0 to USB 2.0
converter for USB I/O port
USB3.0→USB2.0
変換キット (I/Oポート用)

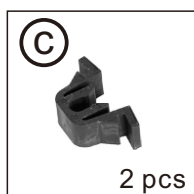

2 pcs
Female clip
for side panel (spare part)
サイドパネル用
メス型クリップ



12 pcs
Anti-vibration rings
for 3.5" / 2.5" HDD
3.5"/2.5"HDD用
防振ゴム

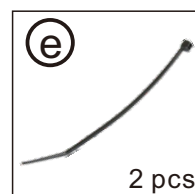

2 pcs
Cable ties
for cable management
ケーブルタイ



4 pcs
Screws
for PSU Mounting
電源固定用ネジ



5 pcs
Screws for ODD Mount
ODDマウント用ネジ



4 pcs
Screws for M/B Mount
マザーボード固定用
M3ネジ

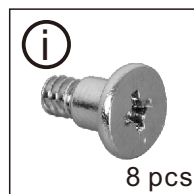

8 pcs
Screws
for 3.5" HDD
3.5" HDD用ネジ

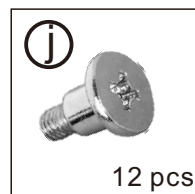

12 pcs
Screws M3 x 9.5 mm
for 2.5" HDD
2.5"HDD用
M3 x 9.5 mm ネジ

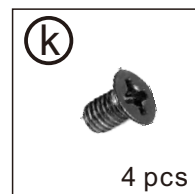

4 pcs
Screws M3 x 5 mm
for 2.5" HDD
2.5"HDD用
M3 x 5 mm ネジ

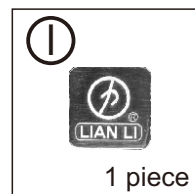

1 piece
LIAN LI

- * Remove the side panel
- * 側板拆卸
- * Retirez le panneau latéral
- * Seitenwand abnehmen
- * Extracción del panel lateral
- * サイドパネルの取り外し

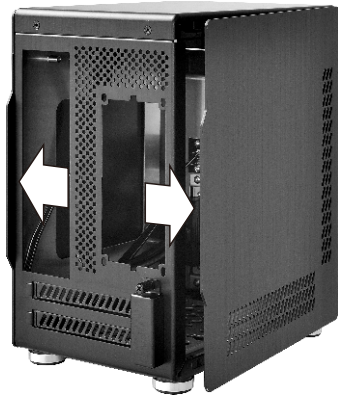

- * Motherboard installation
- * 主板安裝
- * Installation de la carte mère

- * Motherboard installieren
- * Instalación de la placa base
- * マザーボードの取り付け

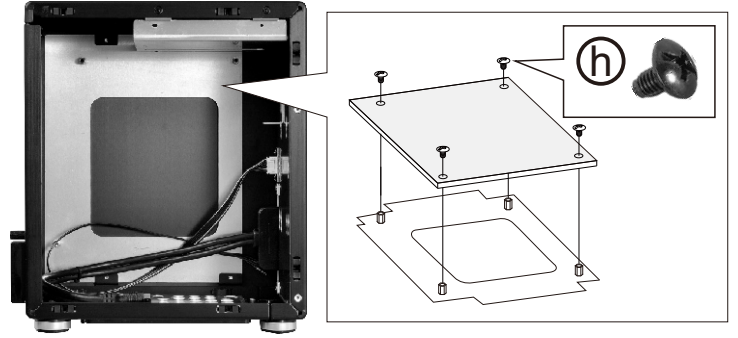

- * ODD installation
- * 光碟機安裝
- * Installation de l'ODD
- * Optisches Laufwerk installieren
- * Instalación de la unidad de disco óptico
- * 光学ドライブの取り付け

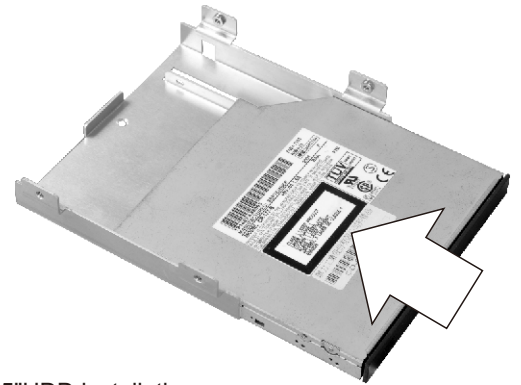
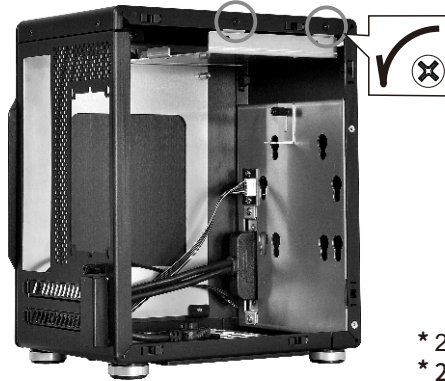
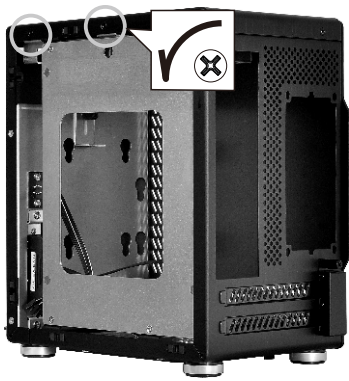

- * 2.5" HDD installation
- * 2.5吋硬碟安裝
- * Installation d'un DD 2.5"
- * 2.5-Zoll-Festplatte installieren
- * Instalación de unidad de disco duro de 2.5"
- * 2.5"ハードディスクの取り付け

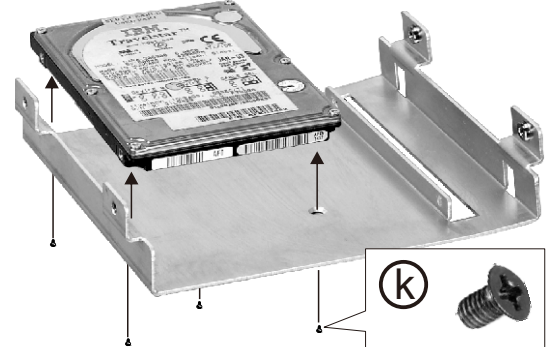
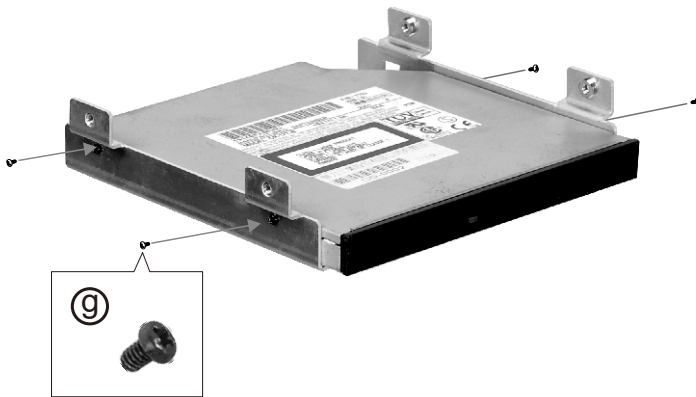

- * PSU installation
- * 電源供應器安裝
- * Installation du plateau du bloc d'alimentation

- * PSU-Einsatz installieren
- * Instalación de la fuente de alimentación
- * 電源ユニットの取り付け

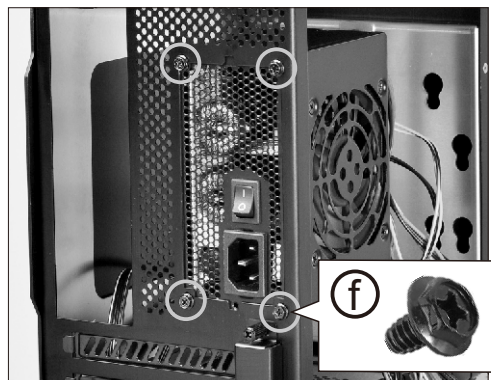

- * 2.5" HDD installation
- * Installation d'un DD de 2,5"
- * Instalación de una unidad de disco duro de 2.5"
- * 2.5吋硬碟安裝
- * 2,5-Zoll-Festplatte installieren
- * 2.5" HDDの取り付け

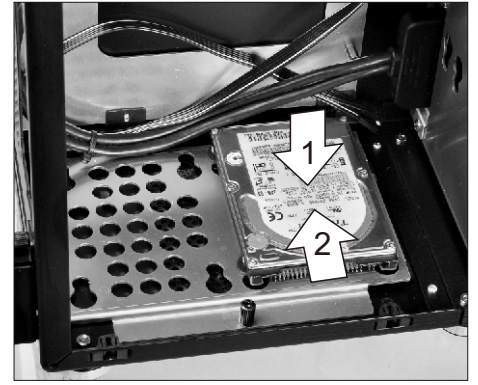
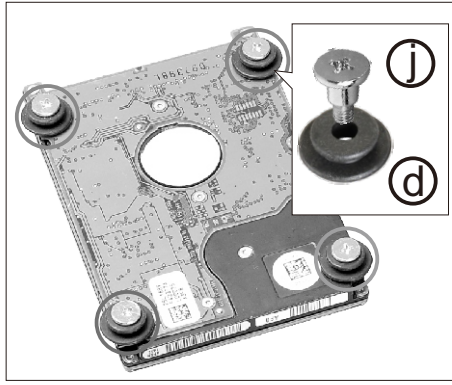

- * 3.5" HDD installation
- * Installation d'un DD de 3,5"
- * Instalación de una unidad de disco duro de 3.5"
- * 3.5吋硬碟安裝
- * 3,5-Zoll-Festplatte installieren
- * 3.5" HDDの取り付け

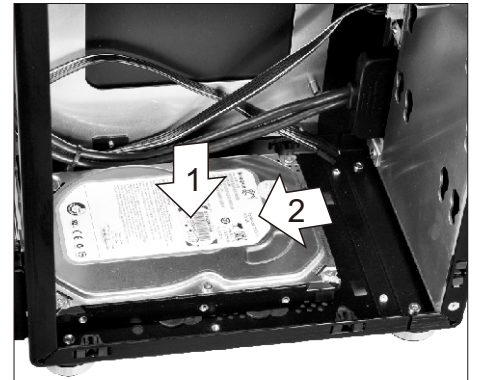
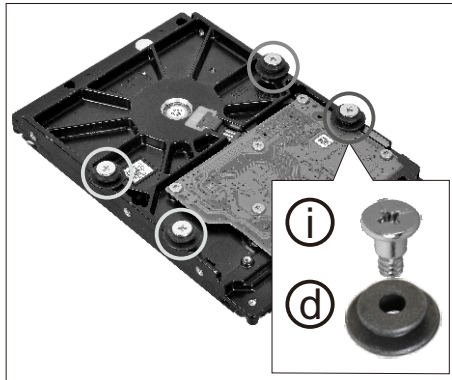
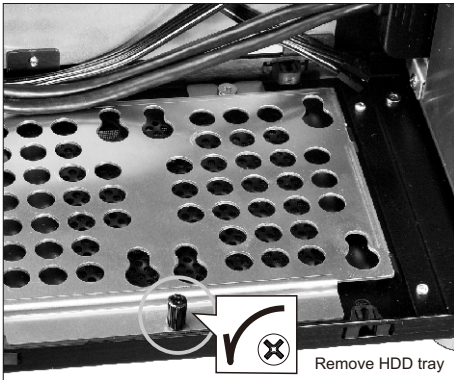

- * 3.5" HDD installation
- * Installation d'un DD de 3,5"
- * Instalación de una unidad de disco duro de 3.5"
- * 3.5吋硬碟安裝
- * 3,5-Zoll-Festplatte installieren
- * 3.5" HDDの取り付け

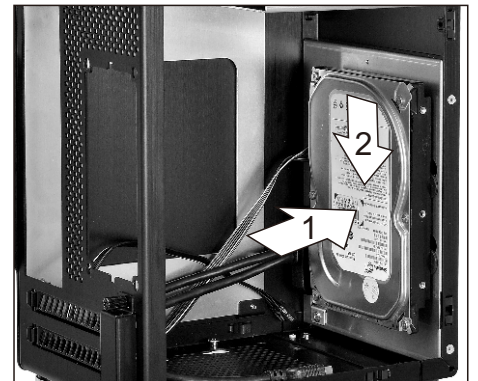
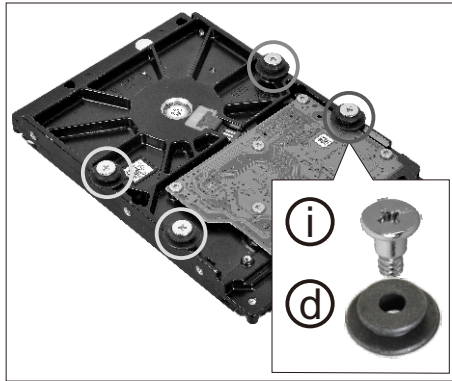

- * 2.5" HDD installation
- * Installation d'un DD de 2,5"
- * Instalación de una unidad de disco duro de 2.5"
- * 2.5吋硬碟安裝
- * 2,5-Zoll-Festplatte installieren
- * 2.5" HDDの取り付け

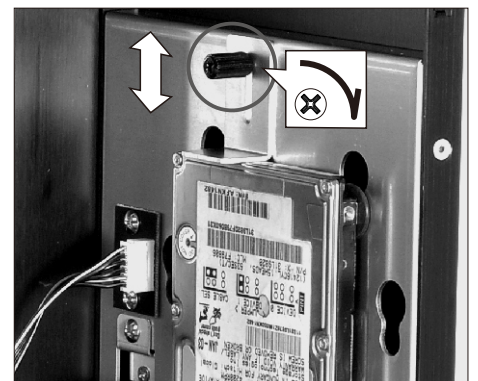
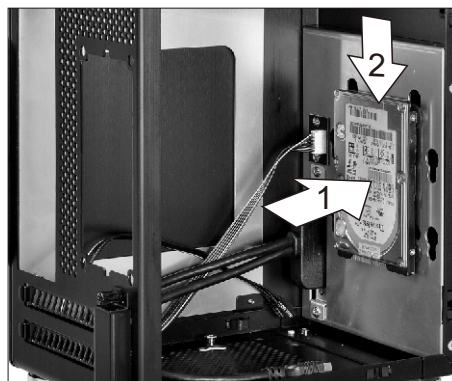
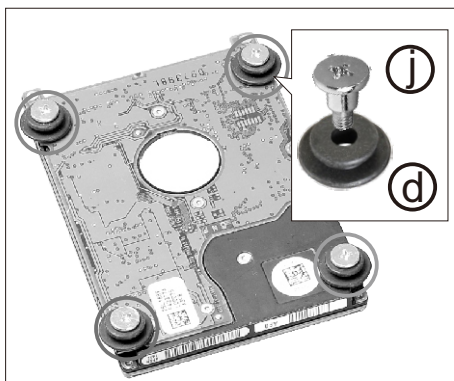

- * Optional - Fan - Installation * Optionnel - Ventilateur - Installation * Opcional - del ventilador - Instalación
- * 選配-風扇-安裝 * Optional - Lüfter - Installation * オプション-ファン-インストール

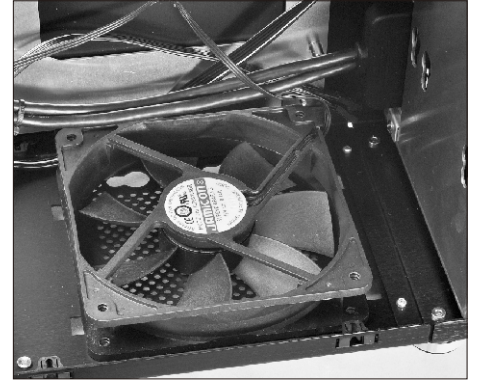
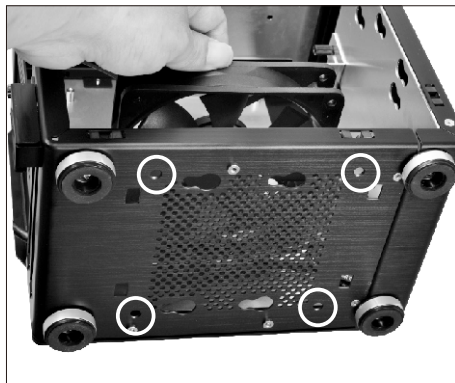
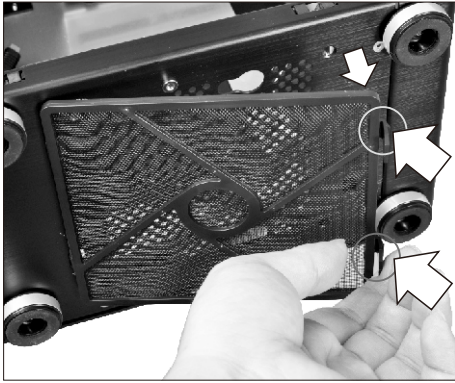

- * I/O port installation
- * USB 3.0 接線定義
- * Installation du port E/S
- * I/O-Port installieren
- * Instalación de los puertos de E/S
- * 外部I/Oポートに関して

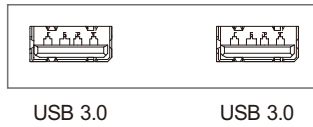

Supports motherboard
USB 3.0 20 Pin header

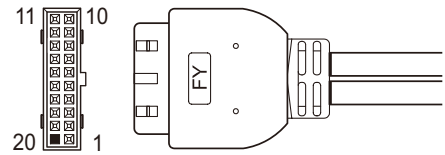

- * USB 3.0 to USB 2.0 converter
- * USB 3.0 轉 2.0 接線定義
- * Convertisseur USB 3.0 / USB 2.0
- * USB 3.0-zu-USB 2.0-Konverter
- * Convertidor USB 3.0 a USB 2.0
- * USB3.0→USB2.0変換キットに関して

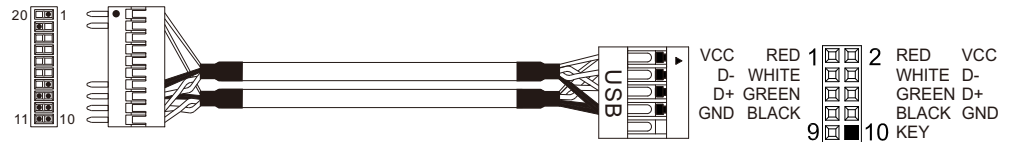

- * Cable installation guide
- * 電源/系統指示燈接線定義
- * Diagramme d'installation des câbles
- * Kabel installieren
- * Guía de instalación de los cables
- * マザーボード接続ケーブルに関して

